

# HITACHI

COLOR

MONITOR

## V810

# USER'S MANUAL MANUEL D'UTILISATION

with **EasyMenu** !

**EasyMenu** is HITACHI's On Screen Display function for easy operation.

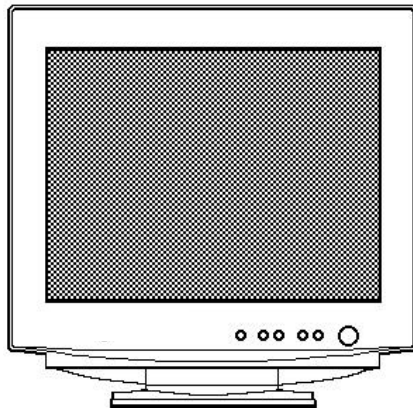

**READ THE INSTRUCTIONS INSIDE CAREFULLY.  
KEEP THIS USER MANUAL FOR FUTURE REFERENCE.**

For future reference, record the serial number of your color monitor.

SERIAL No. \_\_\_\_\_

The serial number is located on the rear of the monitor.

This monitor is ENERGY STAR<sup>®</sup> compliant when used with a computer equipped with VESA DPMS.

The ENERGY STAR<sup>®</sup> emblem does not represent EPA endorsement of any product or service.

As an ENERGY STAR<sup>®</sup> Partner, Hitachi, Ltd. has determined that this product meets the ENERGY STAR<sup>®</sup> guidelines for energy efficiency.



# Limited Warranty For USA Customers Only

Hitachi America, Ltd. (HAL) warrants our Hitachi color monitor to be free from defects in material and workmanship for 36 months from the date you purchased it from your authorized HAL dealer. In the event of a defect during this 36 months period, HAL will, at its option, repair or replace the monitor at no charge except as set forth below. This warranty extends to the original purchaser only and cannot be transferred to another individual or company. HAL's entire liability and your exclusive remedy for valid warranty claims shall be that HAL will repair your monitor with new or reconditioned parts or replace it with a comparable new or reconditioned monitor, and any replaced monitors or parts become HAL's property.

This limited warranty does not cover damage occurring after you purchase the monitor in shipping or in storage or that caused by abuse, accident, disaster, misuse, mishandling, mispackaging or shipping, improper installation, unauthorized repair or modification, or failure to follow the manufacturer's instruction with respect to the proper handling, operation, installation, service and maintenance of the monitor. To obtain warranty service, call 1-800-536-6721 for a return authorization number and the location of your nearest HAL service center, or return the monitor to the dealer from whom you bought it. If you choose to ship the monitor to us rather than delivering it in person, you must assume the risk of damage or loss in transit. You must also use the original shipping container (or equivalent packaging), pay shipping charges, and enclose a copy of the proof of purchase date with the monitor. For additional information, please write to:

Hitachi  
2000  
Brisbane, CA 94005-1835

Sierra  
Point

America,  
Parkway,

Ltd.

NEVER open the monitor cabinet. If the monitor is not operating properly, contact the HAL service center (Call 1-800-536-6721). Do not open the monitor housing under any circumstances. By opening the monitor housing you will expose yourself to high voltage and possible severe electrical shocks and void all warranties.

HAL MAKES NO OTHER WARRANTIES REGARDING THESE PRODUCTS. NO PERSON, AGENT, DISTRIBUTOR, DEALER, SERVICE FACILITY OR COMPANY IS AUTHORIZED TO CHANGE, MODIFY OR AMEND THE TERMS OF THIS LIMITED WARRANTY IN ANY WAY. ANY IMPLIED WARRANTY OF MERCHANTABILITY OR FITNESS FOR A PARTICULAR PURPOSE ON THIS MONITOR IS LIMITED TO THE 36 MONTH DURATION OF THIS WRITTEN WARRANTY. ALL WARRANTIES SET FORTH IN THIS WARRANTY ARE LIMITED TO 36 MONTHS FROM THE DATE OF PURCHASE. NO WARRANTIES WHATSOEVER WILL COVER THIS MONITOR BEYOND 36 MONTHS. HOWEVER, SOME STATES DO NOT ALLOW LIMITATIONS ON HOW LONG AN IMPLIED WARRANTY LASTS, SO THE ABOVE LIMITATION MAY NOT APPLY TO YOU.

IF THIS MONITOR IS DEFECTIVE, YOUR ONLY REMEDY IS REPAIR OR REPLACEMENT, AS DESCRIBED ABOVE. UNDER NO CIRCUMSTANCES WILL HAL BE LIABLE FOR INCIDENTAL OR CONSEQUENTIAL DAMAGES, INCLUDING ANY LOST SAVINGS, LOST PROFITS, OR ANY OTHER DAMAGES CAUSED BY THE USE OF THIS MONITOR OR INABILITY TO USE IT, EVEN IF THE DEALER OR HITACHI AMERICA HAS BEEN ADVISED OF SUCH LIABILITY OR OTHER CLAIMS. SOME STATES DO NOT ALLOW THE EXCLUSION OR LIMITATION OF INCIDENTAL OR CONSEQUENTIAL DAMAGES SO THE ABOVE LIMITATION OR EXCLUSION MAY NOT APPLY TO YOU. THIS WARRANTY GIVES YOU SPECIFIC LEGAL RIGHTS, AND YOU MAY HAVE OTHER RIGHTS WHICH VARY FROM STATE TO STATE.

**CONTENTS**

FEATURES ..... 1  
 CAUTIONS ..... 2  
 INSTALLATION ..... 6  
 STANDARD SETTINGS ..... 8  
 OPERATION ..... 9  
 POWER SAVING SYSTEM ..... 16  
 PLUG & PLAY ..... 16  
 SPECIFICATIONS ..... 17

**FEATURES**

The following features are provided by the Colour Monitor.

**Sharpest Focus and Highest Contrast**

Flat screen CRT with anti-glare, dynamic focus circuit, dark glass, and an INVAR shadow mask gives the sharpest focus and highest contrast to minimize eye fatigue.

**Wide-range Multi-Scanning**

Automatic scanning and automatic adjustment to conform with a wide range of scanning frequencies and user requirements.

**Digital Picture Control Function**

Position, size, rotation, pincushion, trapezoid, right pincushion and right trapezoid are adjustable by digital controls. Geometry setting can be stored for different H/V frequencies. Microprocessor-based preset functions can store 26 sets of geometry settings including the standard factory settings.

**Digital Colour Control Function**

Red, green, and blue colour balance is adjustable by digital control. An adjusted colour setting can be stored and recalled by the colour select button.

**Power Saving System**

The Environmental Protection Agency (EPA) has established a voluntary program by which manufacturers enable computer products to go into low power states while not being used. This monitor has a low power "sleep" mode, which is compliant with the EPA requirements for the ENERGY STAR® program, and will assist you in conserving energy. Please refer to the section of "POWER SAVING SYSTEM" for details.

**EasyMenu**

An On Screen Display function that allows direct access to adjust all operations from the front switches.

**Moire Reduction**

This monitor has horizontal and vertical moire reduction function.

**PLUG & PLAY**

This monitor is VESA DDC1/2B compliant when used with a computer compliant with VESA DDC (Display Data Channel).





## CAUTIONS

### NEVER REMOVE THE REAR COVER !

The rear cover MUST be removed only by authorized service personnel. This colour monitor contains high voltage components.

### THE RECEPTACLE SHOULD BE CLOSE TO THE MONITOR AND EASILY ACCESSIBLE !

### INSTALL THE UNIT IN AN SUITABLE ENVIRONMENT !

DO NOT expose this monitor to rain or moisture to prevent electric shock or fire hazard. This unit is designed to be used in an office or business environment. DO NOT subject the unit to vibrations, dust, or corrosive gases.

### KEEP IN A WELL VENTILATED PLACE !

DO NOT cover this monitor or place anything against any sides (not only the top, right and left side but also the rear and bottom side) of unit. Ventilation holes are provided at all sides of the rear cover to prevent the temperature from rising.

### KEEP AWAY FROM HEAT SOURCES !

AVOID placing the unit in direct sunshine or near a heating appliance.

### BE CAREFUL OF MAGNETIC FIELDS !

DO NOT place a magnet, loudspeaker system, floppy disk drive, printer, or anything which will generate magnetism near the unit. A magnetic field may cause blurred colours or distortion of the displayed pattern.

### BE CAREFUL OF GENERATED MAGNETISM !

After the power has been turned on or "DEGAUSS" button has been pressed, the CRT is demagnetized for approximately 10 seconds. This generates a strong magnetic field around the front cover which may affect the data stored on magnetic tape or disks near the front cover. Place such magnetic recording equipment and tapes/disks away from this unit.

### AMBIENT ILLUMINATION

Avoid direct rays of the sun or room lighting onto the CRT screen in order to prevent eye fatigue.

### THE ENCLOSED POWER CORD MUST BE USED !

In Europe, a proper European standard approved power cord is to be used with this monitor. For a rated current up to 6 A, a type not lighter than H05VV-F 3G 0.75 mm<sup>2</sup> or H05VVH2-F 3G 0.75 mm<sup>2</sup> must be used.

In USA/Canada, use a UL LISTED/CSA LABELLED or CERTIFIED power cord set meeting the following specifications

Rating:	min.	125V,	7A
Length:		max.	3.0m
Type:	SVT	or	SJT
Plug type: NEMA 5-15P figure, Parallel blade, Grounding type			

Failure to do so may cause fire or electric shock hazard.

### USE ONLY THE CORRECT VOLTAGE POWER OUTLET WITH SAFETY GROUND CONNECTION !

100	-	120	V	for	USA,	Canada,	etc.
200	-	240	V	for		Europe,	etc.

(This monitor will automatically adjust to the input voltage 100 - 120 / 200 - 240V.)

**CAUTION for 200 - 240V operation only**

This equipment relies on the protective devices in the building installation for short-circuit and over-current protection. Refer to the following table for the suitable number and location of the protective devices which should be provided in the building installation.

***Informative examples of protective devices in single - phase equipment or sub - assemblies***

	Protection against	Minimum number of fuses or circuit - breaker poles	Location
Case A: Equipment to be connected to POWER SYSTEMS with earthed neutral reliably identified, except for Case C below.	Earth faults	1	Phase conductor
	Overcurrent	1	Either of the two conductors
Case B: Equipment to be connected to any supply, including IT POWER SYSTEMS and supplies with reversible plugs, except for Case C below.	Earth faults	2	Both conductors
	Overcurrent	1	Either of the two conductors
Case C: Equipment to be connected to 3-wire power systems with earthed neutral reliably identified.	Earth faults	2	Each phase conductor
	Overcurrent	2	Each phase conductor

Verify that the protective devices in the building installation meets the conditions in the table prior to installing the equipment.

**BE CAREFUL OF POWER CORD CONNECTION !**

Before inserting the plug of the power cord into a receptacle of the correct voltage, check that the connection portion of the power cord is clean (with no dust). Then, insert the plug of power cord to a receptacle firmly, otherwise it may cause electrical shock or fire.

**REMOVE THE POWER CORD FOR COMPLETE SEPARATION !**

For complete separation from the power source, remove the power cord from the monitor or from the wall outlet.

**AVOID FREQUENT POWER ON-OFF SWITCHING !**

DO NOT repeat OFF and ON in a short period. It may cause blurred colours or distortion of the displayed pattern.

**BE CAREFUL OF STATIC ELECTRICITY ON CRT SURFACE !**

To prevent electrical shock by the static electricity on the CRT surface, disconnect the power cord at least 30 SECONDS AFTER turning off the power.

**ABOUT**

This monitor has a non-glare and anti-electrostatic treatment on the surface of the screen. Use water or alcoholic solvent with soft cloth like gauze to clean the surface of the screen. NEVER use abrasive, glass cleaner containing highly concentrated ammonia and strong base chemicals since they damage the surface treatment. Clean the cabinet and controls with a lightly moistened soft cloth. DO NOT use aerosol sprays, solvents or abrasive cleaners.

**CLEANING**

## FCC (Federal Communications Commission) STATEMENT WARNING

**WARNING** : This equipment has been tested and found to comply with the limits for a Class B digital device, pursuant to Part 15 of the FCC Rules. These limits are designed to provide reasonable protection against harmful interference in a residential installation. This equipment generates, uses, and can radiate radio frequency energy and, if not installed and used in accordance with the instructions, may cause harmful interference to radio communications. However, there is no guarantee that interference will not occur in a particular installation. If this equipment does cause harmful interference to radio or television reception, which can be determined by turning the equipment off and on, the user is encouraged to try to correct the interference by one or more of the following measures:

Reorient or relocate the receiving antenna.

Increase the separation between the equipment and receiver.

Connect the equipment into an outlet on a circuit different from that to which the receiver is connected.

Consult the dealer or an experienced radio / TV technician for help.

**Instructions to Users** : This equipment complies with the requirements of FCC (Federal Communication Commission) equipments provided that following conditions are met.  
 (1) Power cord : Unshielded power cord must be used.  
 (2) Video inputs : The input signal amplitude must not exceed the specified level.

**CAUTION** : Changes or modifications not expressly approved by the party responsible for compliance could void the user's authority to operate the equipment.

<b>Declaration of Conformity</b> According to 47CFR, Part 2 and 15 for <b>Class B Personal Computers and          Peripherals; and / or          CPU Boards and Power Supplies used          with Class B Personal Computers:</b>	
<b>We:</b>	<u>Hitachi America, Ltd.</u>
<b>Located at:</b>	<u>2000 Sierra Point Parkway, Brisbane, CA 94005-1835 U.S.A.</u>
<p>Declare under sole responsibility that the product identified herein, complies with 47CFR Part 2 and 15 of the FCC rules as a Class B digital device. Each product marketed, is identical to the representative unit tested and found to be compliant with the standards. Records maintained continue to reflect the equipment being produced can be expected to be within the variation accepted, due to quantity production and testing on a statistical basis as required by 47CFR § 2.909. Operation is subject to the following two conditions: (1) This device may not cause harmful interference, and (2) This device must accept any interference received, including interference that may cause undesired operation. The above named party is responsible for ensuring that the equipment complies with the standards of 47CFR § 15.101 to 15.109.</p>	
<b>Trade name:</b>	<u>Color Monitor, USB HUB Module</u>
<b>Model Number:</b>	<u>CM810/CM811/CM813/CM815 + DUB-01**</u>
<b>Signature of Party Responsible:</b>	
<b>Printed name of Party Responsible:</b>	<u>Hideali Kusaba</u>
<b>Executed on (Date), at (Place):</b>	<u>February 28, 2001 CA, U.S.A.</u>

### FOR THE CUSTOMERS IN CANADA for models

**NOTICE** : This Class B digital apparatus complies with ICES-003.

## FOR THE CUSTOMERS IN THE U.K.

THIS PRODUCT IS SUPPLIED WITH A TWO PIN MAINS PLUG FOR USE IN MAINLAND EUROPE. FOR THE U.K. PLEASE REFER TO THE NOTES ON THIS PAGE.

### IMPORTANT FOR UNITED KINGDOM

#### WORDING FOR CLASS EQUIPMENT INSTRUCTION BOOKS AND LABELS

The mains lead on this equipment is supplied with a moulded plug incorporating a fuse, the value of which is indicated on the pin face of the plug. Should the fuse need to be replaced, an ASTA or BSI approved BS 1362 fuse must be used of the same rating. If the fuse cover is detachable never use the plug with the cover omitted. If a replacement fuse cover is required, ensure it is of the same colour as that visible on the pin face of the plug. Fuse covers are available from your dealer.

DO NOT cut off the mains plug from this equipment. If the plug fitted is not suitable for the power points in your home or the cable is too short to reach a power point, then obtain an appropriate safety approved extension lead or consult your dealer.

Should it be necessary to change the mains plugs, this must be carried out by a competent person, preferably a qualified electrician.

If there is no alternative to cutting off the mains plug, ensure that you dispose of it immediately, having first removed the fuse, to avoid a possible shock hazard by inadvertent connection to the mains supply.

### **WARNING: THIS EQUIPMENT MUST BE EARTHED**

#### **IMPORTANT**

The wires in the mains lead are coloured in accordance with the following code:

Green and Yellow = Earth, Blue = Neutral, Brown = Live.

As these colours may not correspond with the coloured markings identifying the terminals in your

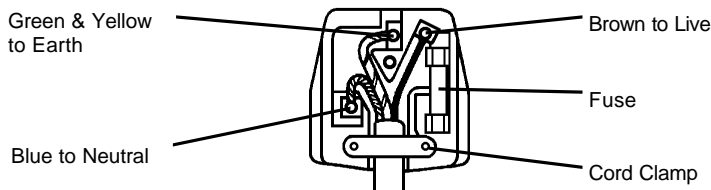

plug, proceed as follows:

The wire which is coloured GREEN and YELLOW must be connected to the terminal in the plug which is marked with the letter E or by the earth symbol  $\oplus$  or coloured GREEN or GREEN and YELLOW.

The wire coloured BLUE must be connected to the terminal marked with the letter N or coloured BLUE or BLACK. The wire coloured BROWN must be connected to the terminal marked with the letter L or coloured BROWN or RED.



# INSTALLATION

Install the monitor in the following way, taking care to maintain safety.

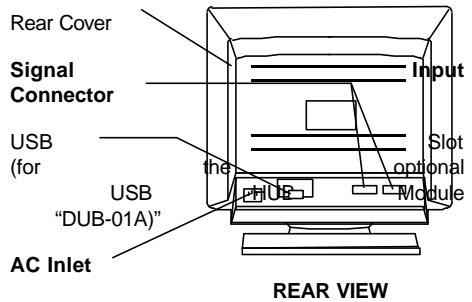
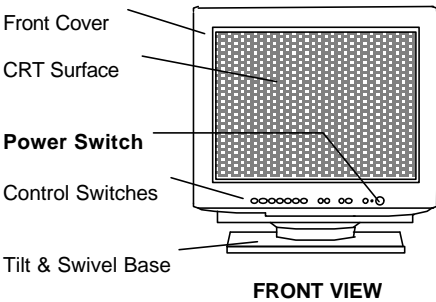

## 1. Installation

Install the monitor on a horizontal base.

## 2. Power Cord Connection

Make sure of using the power cord meeting the safety standard of the country in which you are using the monitor.

Insert the connector of a power cord to the AC Inlet of the monitor.

Insert the plug of the power cord to a receptacle of the correct voltage.

## 3. Signal Cable Connection

Use video signal cable which is included in the carton box.

(Cable model name:HD-0501FXL)

Insert the connector of a signal cable to the Signal Input Connector Input 1 or Input 2 of the monitor, with attention to the suitability, and secure the screws on the connector shell firmly.

Connect the other connector end of the signal cable to the host computer.

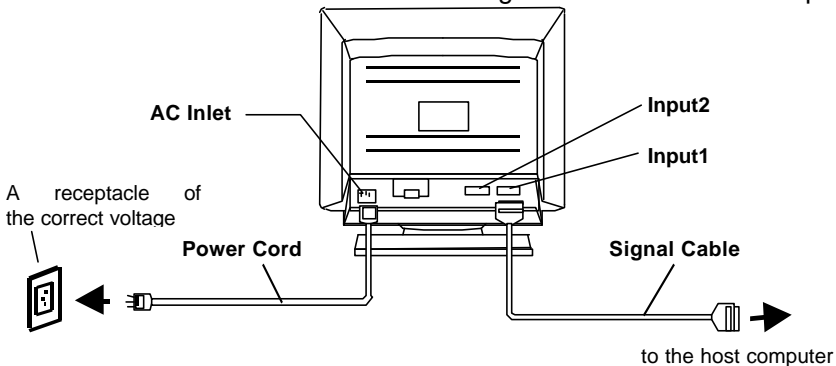

Use a signal cable with the D-Sub Mini 15-pin Connector.

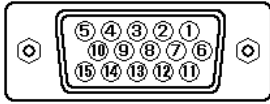

Pin No.	Input 1	Input 2
1	Red Video	Red Video
2	Green Video (Sync. optional)	Green Video (Sync. optional)
3	Blue Video	Blue Video
4	No Pin	No Pin
5	No connection	No connection
6	Red Ground	Red Ground
7	Green Ground	Green Ground
8	Blue Ground	Blue Ground
9	No connection	No connection
10	Ground	Ground
11	No connection	No connection
12	Bi-directional Data [SDA]	No connection
13	H.Sync. (or H/V)	H.Sync. (or H/V)
14	V. Sync. [VCLK]	V. Sync.
15	Data Clock [SCL]	No connection

If the graphics board supplies more than one type of sync. signal, the sync. signal type will be automatically selected by the monitor, with the priority shown in the following table.

Sync. Signal Type	Priority
H, V Separate Sync.	1
H / V Composite Sync.	2
Sync. on Green Video	3

#### 4. Power On

Turn on the Power Switch of the monitor first, then the computer. Refer to Page 9 "POWER ON/OFF".

#### **NOTICE :**

After turning OFF the switch, wait at least 5 seconds to restart the monitor. Otherwise the monitor may operate unusually.

If the picture doesn't appear, turn OFF the power switch, make sure of the following and wait at least 30 seconds to restart the monitor.

Make sure the power switch of the computer, power cord connection, signal cable connection and the input sync. signal are right.

If the Colour is impure on the screen after turning ON the monitor, wait for about 10 minutes and press the Degauss button.

## STANDARD SETTINGS

Microprocessor-based preset functions can store 26 sets of geometry settings including the standard settings. The following industrial standard settings have been pre-programmed by the factory.

No.	Video Mode Name (with Resolution and Vertical Frequency)	Horizontal Frequency	Video Mode
1	VGA 640 × 400 - 70 Hz	31.47 kHz	VGA
2	VESA 640 × 480 - 60 Hz	31.49 kHz	VESA
3	VESA 800 × 600 - 85 Hz	53.67 kHz	VESA
4	VESA 1024 × 768 - 85 Hz	68.68 kHz	VESA
5	VESA 1152 × 864 - 75 Hz	67.50 kHz	VESA
6	Mac 1152 × 870 - 75 Hz	68.68 kHz	Mac
7	VESA 1280 × 1024 - 85 Hz	91.15 kHz	VESA
8	VESA 1600 × 1200 - 75 Hz	93.75 kHz	VESA

### NOTE :

Input signals with approximately the same frequencies may be regarded as the same signal.

The following horizontal timing conditions are recommended (at sync. H, V separate or H/V composite).

for 31 kHz - 55 kHz horizontal frequency:  
 Horizontal front porch should be more than 0.1 μs.  
 Horizontal sync. width should be within 1.0 - 3.8 μs.  
 Horizontal back porch should be more than 1.2 μs.  
 Horizontal blanking width should be more than 3.5 μs.

for 55 kHz - 96 kHz horizontal frequency:  
 Horizontal front porch should be more than 0.1 μs.  
 Horizontal sync. width should be within 0.8 - 3.0 μs.  
 Horizontal back porch should be more than 1.1 μs.  
 Horizontal blanking width should be more than 2.3 μs.

The following vertical timing conditions are recommended.

Vertical front porch should be more than 9 μs.  
 Vertical sync. width should be less than 100 μs.  
 Vertical back porch should be more than 400 μs.  
 Vertical blanking width should be more than 450 μs.

In case the front or back porch is extremely long, or the data display time is extremely short, it may not be able to set the expected size and position.

Standard settings are subject to change without notice.

This monitor is tested and conformed compliance with ZH1/618 and EN29241-3 (ISO9241-3) ergonomics requirement on the following video modes :

“VESA 1024× 768 - 85 Hz”, “VESA 1280×1024 - 85 Hz”, “VESA 1600×1200 - 75 Hz”

This monitor is tested and conformed compliance with FCC (and ICES-003) Class B requirement on the video mode “1600×1200 - 92kHz”.

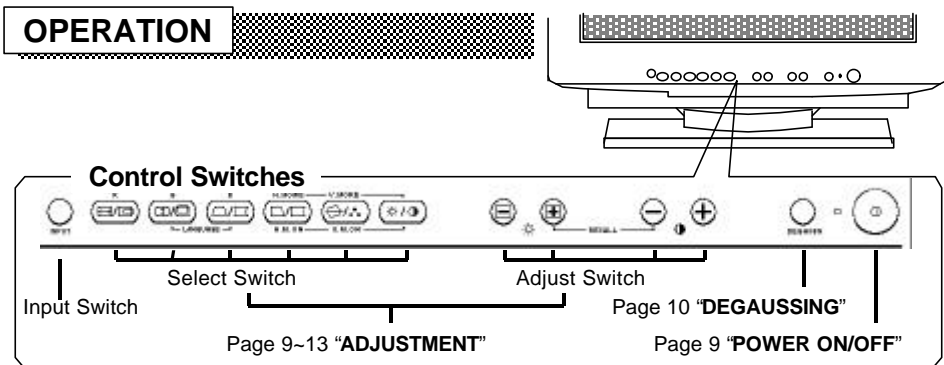

## POWER ON/OFF

Press the Power switch, to switch the power ON or OFF.

When power is ON, the power LED lights.

## INPUT

This monitor has two input terminals, INPUT 1 and INPUT 2. Therefore, you may connect two computers simultaneously. When two computers are active, you may switch the input signal by using the EasyMenu controls.

## INPUT SELECT

INPUT 1 is the initial factory default setting. If you would like to use INPUT 2, proceed to the “EasyMenu” and select the “INPUT SELECT” mode. Press the “+” key and this will select INPUT 2.

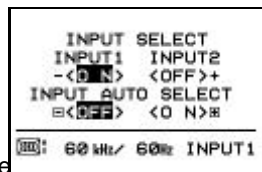

Plug and Play function is only supported on INPUT 1 and not supported on INPUT 2.

Sample of “EasyMenu”

## AUTO INPUT SELECT

This monitor has an “INPUT AUTO SELECT” function which will select the input by scanning for an input signal on either INPUT 1 or INPUT 2.

**“ON” : Press the “ + ” key.**

When there is no input signal received from the input connection which was selected by “INPUT SELECT”, the “INPUT AUTO SELECT” function will select the alternate connection. If there is no input signal received from either connection the monitor will default to the “POWER SAVE” mode.

If there are two computers connected to the monitor and for example you restart one of the computers or it is activated from the “POWER SAVE” mode, it is possible that the monitor may change to an undesired input connection. This may be easily corrected by changing the input selection to the desired INPUT 1 or INPUT 2 using the “INPUT SELECT” function.

**“OFF” : Press the “ [M] ” key.**

When the “INPUT AUTO SELECT” function is placed in the “OFF” mode, the monitor will default back to the selection that has been selected by the “INPUT SELECT” function, and the input will no longer be selected automatically.

## DEGAUSSING

Press the switch “**DEGAUSS**”, to degauss manually.

Use this function only when you see colour impurities on the screen after turning ON the monitor. Remember, the monitor is automatically degaussed during initial power on.

Wait for about 10 minutes before repeating the function.

## ADJUSTMENT

Press the select switch of the item you want to adjust. Then you can adjust by the adjust switches shown in following tables.

You can store the adjusted condition. Refer to Page 14 “STORE”.



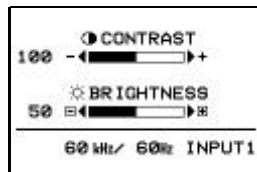
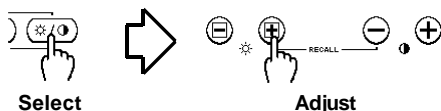

























The On Screen Display function of “EasyMenu” shows selected items and adjusting conditions. You can select the EasyMenu Language. See the table below.



Sample of “EasyMenu”

Item	Select Switch	Adjust Switch		Function	
		☀	☾		
Language Select	☰ and ☱ simultaneously.			+	changes the language to the next mode. ENGLISH DEUTSCH ESPAÑOL ITALIANO FRANÇAIS
				-	changes the language to the previous mode. FRANÇAIS ITALIANO ESPAÑOL DEUTSCH ENGLISH
Contrast	☀/☾			+	makes Contrast brighter excluding background.
				-	makes Contrast darker excluding background.
Brightness			+		makes Brightness brighter including background
			-		makes Brightness darker including background.

ADJUSTMENT (Continue)

Item	Select Switch	Adjust Switch		Function
				
H. Position				moves the position to the right.
				moves the position to the left.
H. Size				expands horizontally.
				shrinks horizontally.
V. Position				moves the position up.
				moves the position down.
V. Size				expands vertically.
				shrinks vertically.
Rotation				rotates clockwise.
				rotates counter clockwise.
Pincushion				curves the left/right sides outwards.
				curves the left/right sides inwards.
Trapezoid				expands the top side, and shrinks the bottom side.
				shrinks the top side, and expands the bottom side.
Right Pincushion				curves the right side outwards.
				curves the right side inwards.
Right Trapezoid				expands the right top side, and shrinks the right bottom side.
				shrinks the right top side, and expands the right bottom side.

ADJUSTMENT (Continue)

Item		Select Switch	Adjust Switch				Function
Colour Select							changes the colour to the next mode. No.1:9300K No.2:6500K No.3:5000K No.4:USER (if available)
							changes the colour to the previous mode. No.4:USER (if available) No.3:5000K No.2:6500K No.1:9300K
Colour Balance	Red	and  simultaneously. When Green or Blue is selected,  is valid singly.					makes the Red stronger. When the Red reaches the upper limit, it makes the Green and Blue weaker.
							makes the Green and Blue stronger. When the Green or Blue reaches the upper limit, it makes the Red weaker.
	Green	and  simultaneously. When Blue or Red is selected,  is valid singly.					makes the Green stronger. When the Green reaches the upper limit, it makes the Blue and Red weaker.
							makes the Blue and Red stronger. When the Blue or Red reaches the upper limit, it makes the Green weaker.
	Blue	and  simultaneously. When Green or Red is selected,  is valid singly.					makes the Blue stronger. When the Blue reaches the upper limit, it makes the Red and Green weaker.
							makes the Red and Green stronger. When the Red or Green reaches the upper limit, it makes the Blue weaker.
	Colour Reset	(This operation is valid only when Red, Green or Blue is selected already.)					cancels the currently adjusted colour, and calls the colour condition of the previously selected colour mode.
			simultaneously, for about 2 seconds.				

When EasyMenu is not shown, you can start the adjustment of Contrast and Brightness only, without pressing any select switch.

It is recommended to follow the following procedures for the adjustment of distortions;

- (1) "Rotation" (Adjust the left side.)
- (2) "Pincushion" and "Trapezoid" (Adjust the left side.)
- (3) "Right Pincushion" and "Right Trapezoid" (Adjust the right side.)

The mode "No.4:USER" is not factory set, and it is programmable if desired. After adjustment of "Colour Balance" (Red, Green or Blue) and "STORE" (refer to page 14), your colour balance will be restored by selecting "No.4:USER".

ADJUSTMENT (Continue)

Item	Select Switch	Adjust Switch		Function
H. Moire Reduction	and  simultaneously.			operates the horizontal moire changing circuit.
				stops the horizontal moire changing circuit.
				makes the operation of the horizontal moire changing circuit stronger.
				makes the operation of the horizontal moire changing circuit weaker.
V. Moire Reduction	and  simultaneously.			operates the vertical moire changing circuit.
				stops the vertical moire changing circuit.
				makes the operation of the vertical moire changing circuit stronger.
				makes the operation of the vertical moire changing circuit weaker.

Moire may appear on the screen due to interference between CRT dot pitch and video signal by conditions of video image, display size, display brightness, etc. Adjust the conditions of display size, display brightness, etc., before the adjustment of moire.

In some cases, this function may cause deterioration of display quality, such as focus, jitter, etc.

The condition of the moire changing circuit will be indicated by pressing any switch (Select Switch or Adjust Switch), as the following.

Indicated symbol	Moire changing circuit condition	
	Horizontal	Vertical
	ON	ON
	ON	OFF
	OFF	ON
not indicated	OFF	OFF



Sample of "EasyMenu"



## STORE

You can store your settings automatically when the EasyMenu is disappeared.

Item	Storing Condition	Restoring Condition
H.Position H.Size V.Position V.Size Pincushion Trapezoid Right Pincushion Right Trapezoid H.Moire Reduction V.Moire Reduction	One setting is allowed for each video mode. You can store maximum 26 sets of geometry settings including the standard settings (refer to page 8 "STANDARD SETTINGS").  If your store is at its maximum already, storing a setting for new video mode overwrites the oldest user setting.  The video mode is distinguished by the horizontal/vertical frequency and polarity of the horizontal/vertical sync. signal. When the video modes are almost similar in these factors, however, the video modes may not be discriminated as different.	When the monitor detects the same video mode.
Colour Balance (Red, Green, Blue)	One setting is allowed to the Colour balance "No.4:USER".	When the colour balance "No.4:USER" is selected.
Rotation	One setting is allowed.	When the monitor detects a valid signal.
Contrast Brightness Colour Select Language Select	One setting is allowed.  It is normally not necessary to store them manually. No operation of about 8 seconds stores the currently adjusting data of these items, automatically.	

## RECALL

To select the factory preset for the current video mode, press  $\oplus$  and  $\ominus$  simultaneously and hold for two seconds. (No other user settings are deleted.)  
The user can then restore new data if required.

## RESET

To reset all user stored settings, turn **ON** the Power switch while pressing  $\ominus$  and  $\oplus$  simultaneously. All user stored settings for each video mode will be deleted when recalling the factory presets. The user can then restore new data if required.

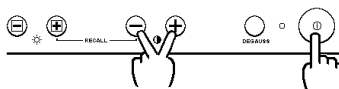

## SIGNAL CHECK

To refer to the input signal condition, press any switch (Select Switch or Adjust Switch). The horizontal frequency and vertical frequency will be indicated.

Precision frequency,  
 Horizontal approximately  $\pm$  2 kHz  
 Vertical approximately  $\pm$  2 Hz

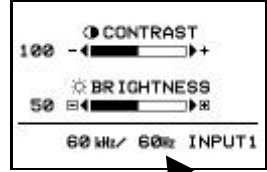

Sample of  
 "EasyMenu"

## AUTOMATIC SIGNAL CHECK

When the monitor has detected the change of the signal input condition, the monitor will indicate the condition automatically, as follows.

Condition	Indication	Sample of "EasyMenu"
When the monitor detects no sync. signal.	The EasyMenu indicates the message "POWER SAVE" for 5 seconds. Verify power switch of the computer and cable connection.	POWER SAVE [INPUT1]
When the monitor will go into the power saving mode. (Refer to page 16)	The LED of the power switch (ⓘ) flashes. Verify power switch of the computer and cable connection.	
When the monitor detects a sync. signal which is out of set-up specification or is unstable.	The EasyMenu indicates the message "INVALID SCAN FREQ." Verify the specification of input signal.	INVALID SCAN FREQ. [INPUT1]

## VIDEO MUTING

When the monitor has detected the change of the signal input condition, the monitor mutes the picture automatically. This function hides scrambled images which may appear during the changing period of the input signal. The muting period depends on the time that takes until the replaced signal becomes stable.

## POWER SAVING SYSTEM

This monitor complies with VESA and ENERGY STAR® power saving requirements. The power saving system works only when used with VESA DPMS compliant PC's and/or graphic controllers.

When to switch the power OFF during the monitor is in OFF mode, sometimes LED flashing continues a few seconds. It is not failure.

VESA DPMS				Power Saving States	
Mode	Video	H. Sync.	V. Sync.	Power	Power LED
ON	Active	Yes	Yes	130 W (typical)	Lighting Green
Stand-by	Blanked	No	Yes	less than 15 W	Flashing quickly
Suspend	Blanked	Yes	No		
OFF	Blanked	No	No	less than 5 W	Flashing Slowly

## PLUG & PLAY

This monitor complies with VESA DDC1/2B specifications. Plug & Play is a system with computer, peripherals (including monitors), and operating system. It works when the monitor is connected to DDC ready computer that is running an operating system software that incorporates plug & play functionality.

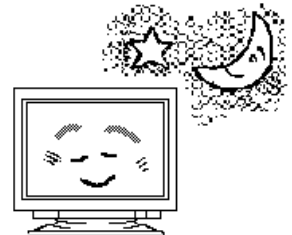

## SPECIFICATIONS

<b>CRT</b>	21 inch picture tube, 0.22 mm horizontal dot pitch (0.21 mm horizontal mask pitch), Invar shadow mask, Black matrix, Short persistence phosphors, New Anti-Reflection coat.		
<b>Input Signal</b>	Video	: 0.70 Vp-p, Analogue	
	Sync.	: Separate H/V,	TTL level
		Composite H/V,	TTL level
		Sync. on Green at 0.30 Vp-p	
<b>Synchronisation</b>	Horizontal	: 31-96 kHz	
	Vertical	: 50-160 Hz	
<b>Resolution (max.)</b>	Horizontal	: 1600 dots	
	Vertical	: 1280lines	
<b>Video Clock frequency</b>	203MHz (typical)		
<b>Viewable Image Size</b>	19.9 inches (505 mm), diagonal (typical)		
<b>Viewable Image Area</b>	Horizontal	: 405mm (typical)	
	Vertical	: 303 mm (typical)	
<b>Colour Temperature</b>	Standard Colour Balance 1	: 9300K	
	Standard Colour Balance 2	: 6500K	
	Standard Colour Balance 3	: 5000K	
	Colour Balance 4	: User defined	
<b>Warm-up Time</b>	30 minutes to reach optimum performance level.		
<b>Power Supply</b>	AC 100 - 120 / 200 - 240 V, automatically selected.		
	Power Consumption	: 130 W	(typical)
	Provided with power save circuit.		
<b>Dimensions</b>	488 (W) × 482 (H) × 470 (D) mm	(including Tilt & Swivel Base)	
<b>Weight</b>	27.5 kg	(approx.)	
	(including Tilt & Swivel Base)		
<b>Environmental Condition</b>		<u>Operation</u>	<u>Storage</u>
	Temperature	5°C to 35°C	20°C to 60°C
	Humidity	10% to 80%	10% to 90%
<b>USB (optional)</b>	<b>Function</b>	USB HUB Module "DUB-01A" with 4 downstream and 1 upstream ports.	

Specification and Design are subject to change without notice.

# **HITACHI**

**Hitachi America, Ltd.**

**2000 Sierra Point Parkway,**

**Brisbane, CA 94005-1835 U.S.A**

**Pre-Sales Support : 1 - 800 - 441 - 4832**

**Technical Support : 1 - 800 - 536 - 6721**

**World Wide Web Home page : <http://www.hitachidisplays.com>**

**In Canada : 1 - 800 - HITACHI or 905 - 821 - 4545**

**World Wide Web Home page : <http://www.hitachi.ca>**